

Data Sheet



Article number: 20379281

Description: E+G Handwheel
GN 323-100-K12-R

Measures

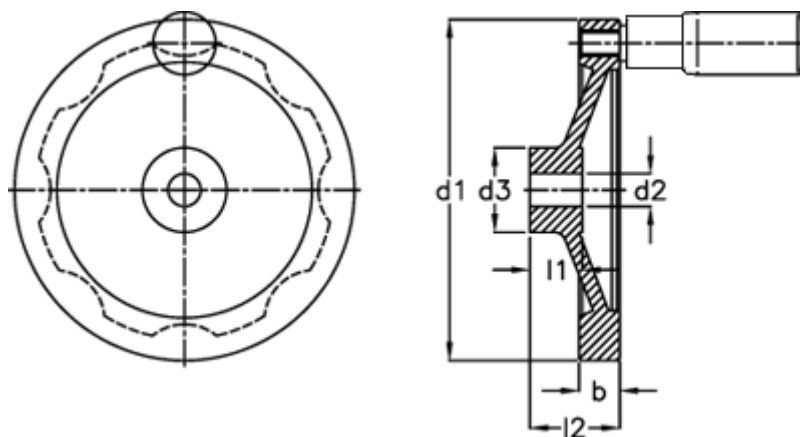

b	= 14.0
d1	= 100
d2 H7	= 12
d3	= 28
Handle	= 18
l1	= 17
l2	= 30